



mobiofic.com
MOBILIARIO DE OFICINA



Confort, tecnología y modularidad son tres de las grandes virtudes de esta serie.

Comfort, technology and modularity are three of the great virtues of this series.

Confort, technologie et modularité sont trois des grandes vertus de cette série.





Salidas	DEPARTURES
12:05 MADRID. PTA.	ATUCHA REF. 17004 3
13:22 SEVILLA. STA.	ATUCHA REF. 2143 -
14:05 SEVILLA. PTA.	ATUCHA REF. 8704 -
14:15 MADRID. PTA.	ATUCHA REF. 2153 5
15:48 BARCELONA. SANTA	REF. 3001 7
16:02 MADRID. PTA.	ATUCHA REF. 2163 7

 **1-8** Acceso a vías
PLATFORMS

CONECTANDO

eSPaCioS + PeRSoNaS + eQUIPaMientoS



ConneCting,
SPaCeS + PeoPLe + eQUIPMent

ConneCteR,
eSPaCeS + PeRSonneS + eQUIPeMent



nos preguntamos qué necesitan los espacios, y la respuesta es que cada espacio tiene su particularidad, su forma y distribución, en definitiva, una solución modular, una solución personalizada.

MODULAR

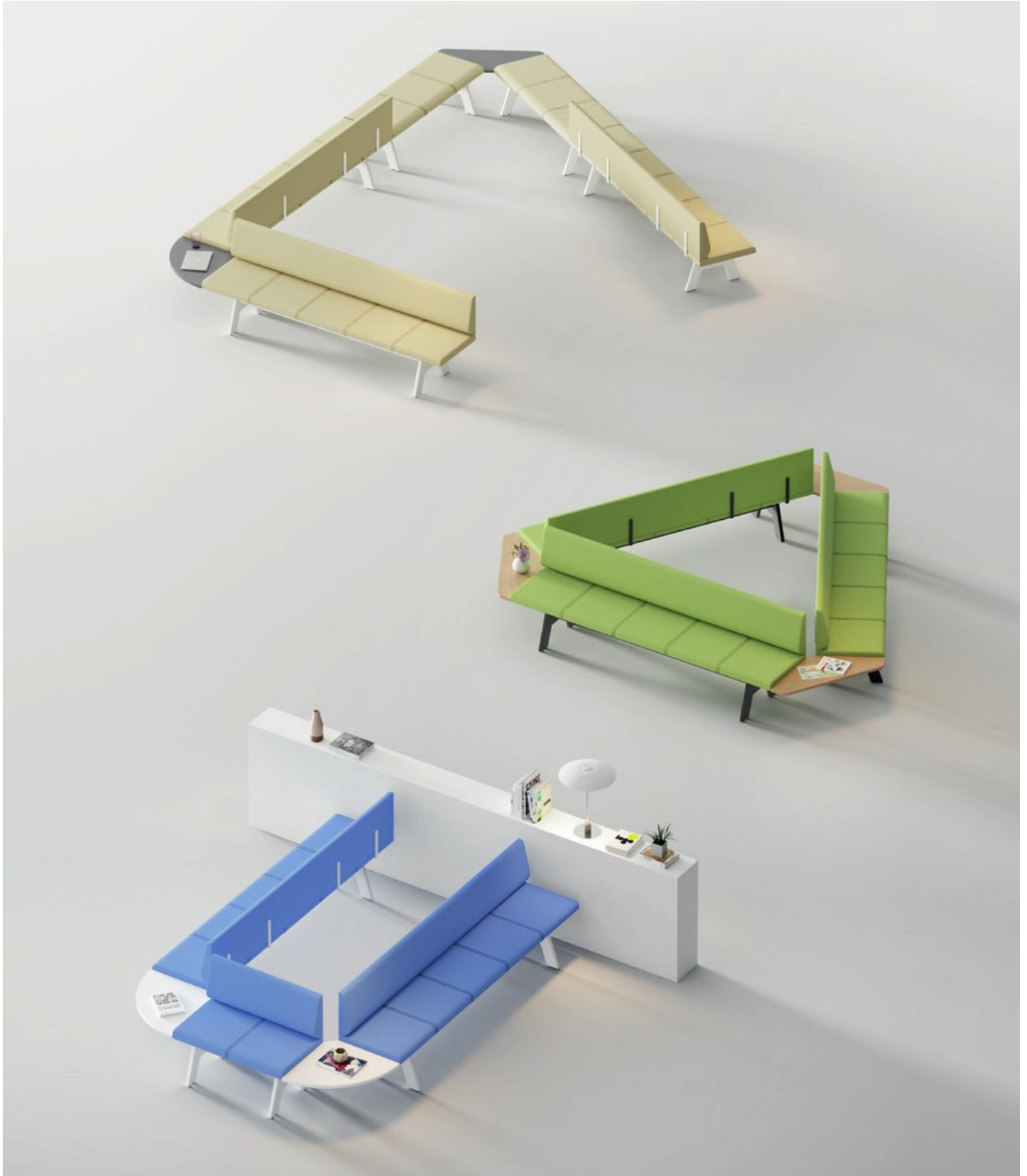



MoDULaR

We wonder what spaces need, and the answer is that each space has its particularity, its shape and distribution, in short, a modular solution, a personalized solution.

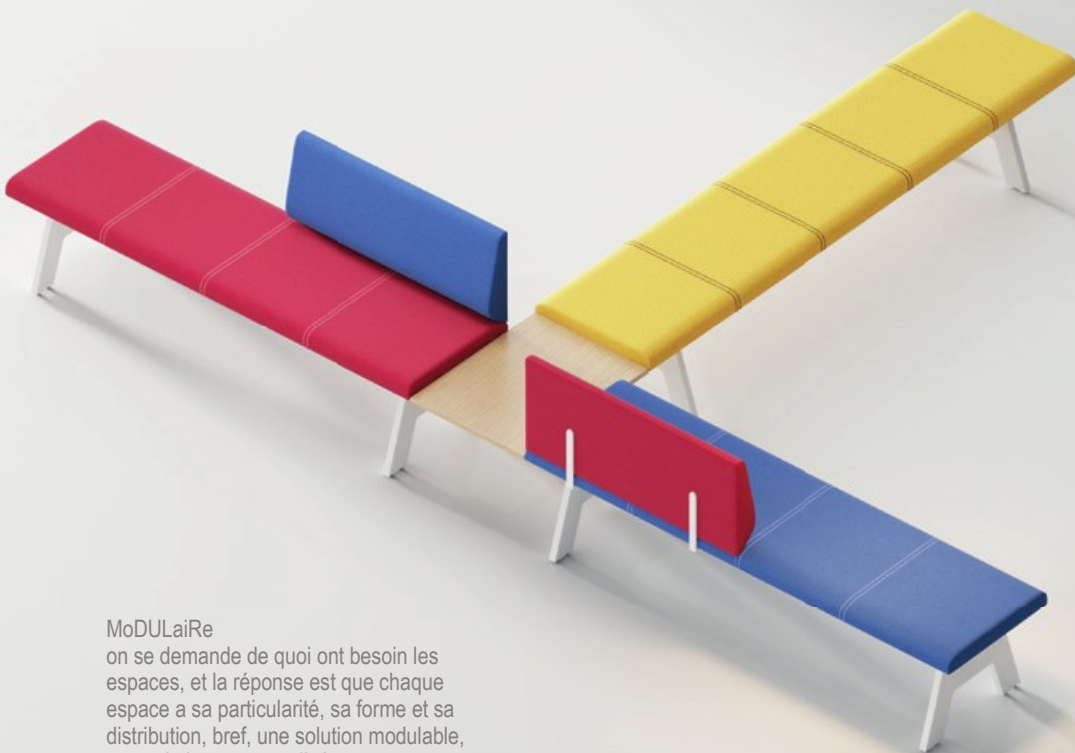

MoDULaiRe

on se demande de quoi ont besoin les espaces, et la réponse est que chaque espace a sa particularité, sa forme et sa distribution, bref, une solution modulable, une solution personnalisée.



FUNCIONAL

Los nuevos usos de los espacios, las necesidades tecnológicas nos llevan a concebir piezas donde convivan el confort y la funcionalidad.

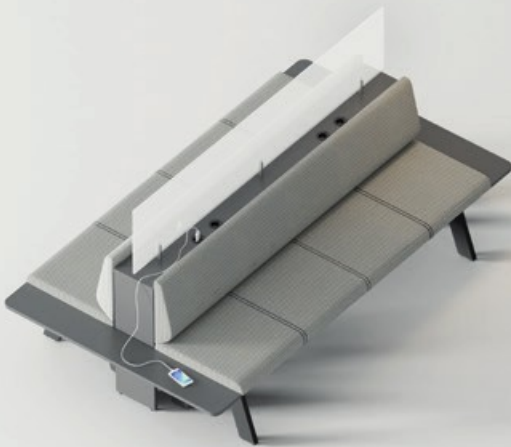

fUnCtional.
the new uses of spaces, technological
needs lead us to conceive pieces where
comfort and functionality coexist.

fonCtionneL
Les nouveaux usages des espaces, les besoins
technologiques nous amènent à concevoir des
pièces où cohabitent confort et fonctionnalité.

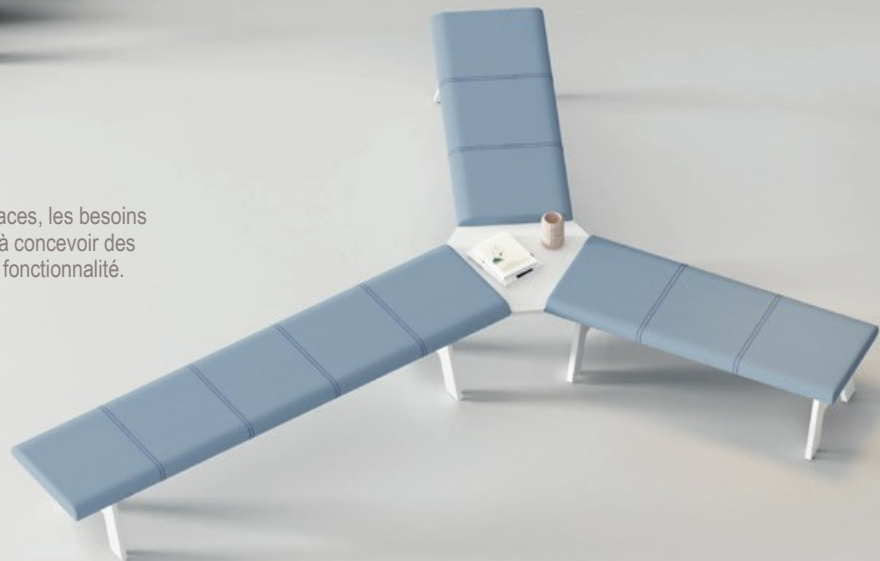

MODULARIDAD FUNCIONAL

Completamente modular, su diseño permite realizar las composiciones que cada espacio precise.

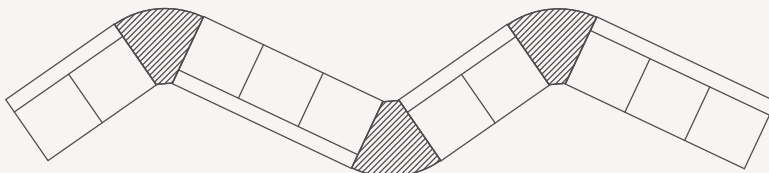
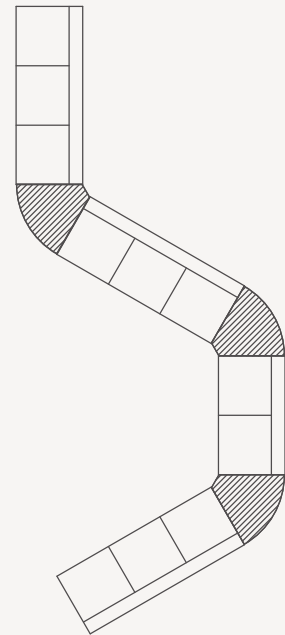
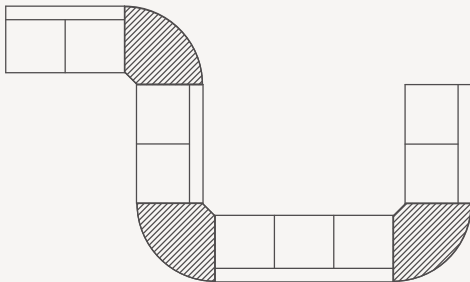
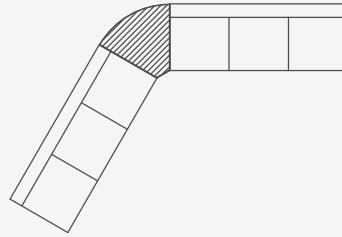
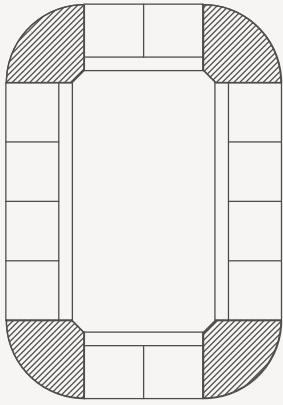
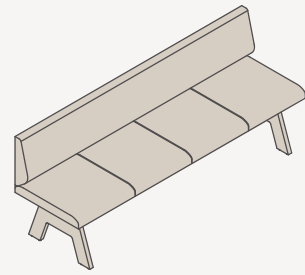
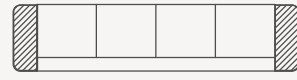
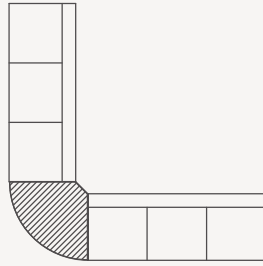
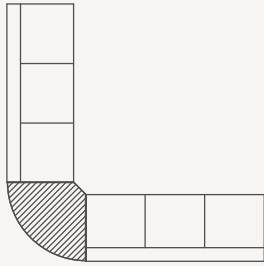

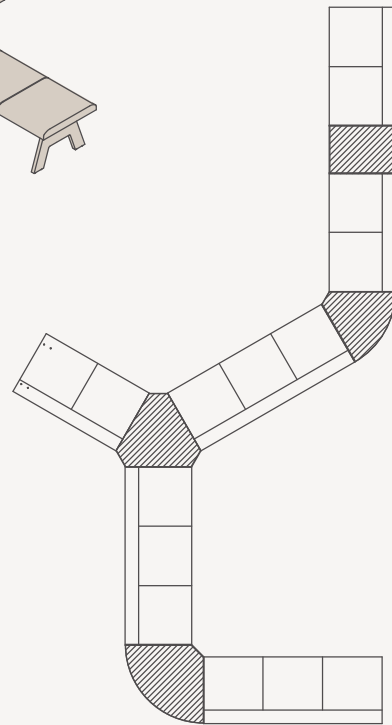
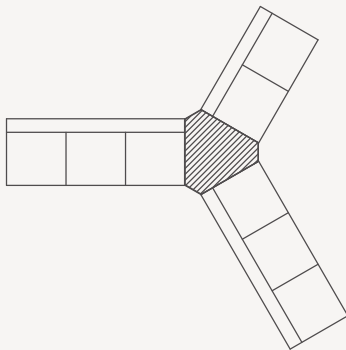
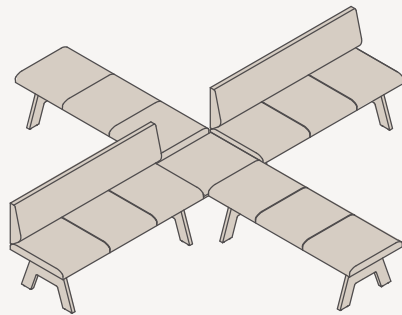
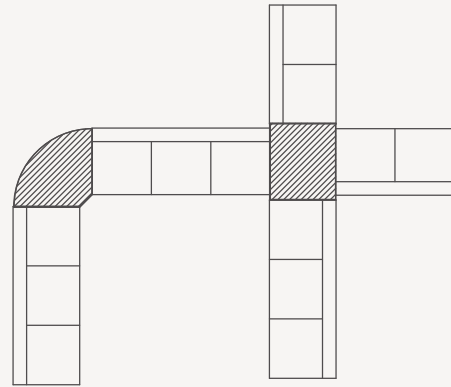
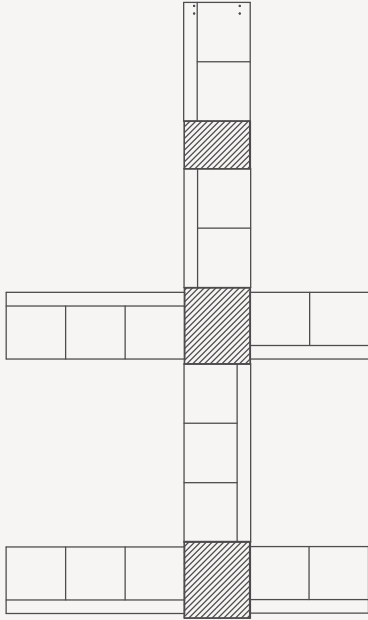
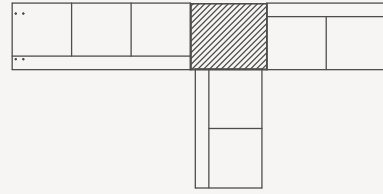

fUnCtionaL MoDULaRitY.
 Completely modular, its design allows to make
 the compositions that each space requires.

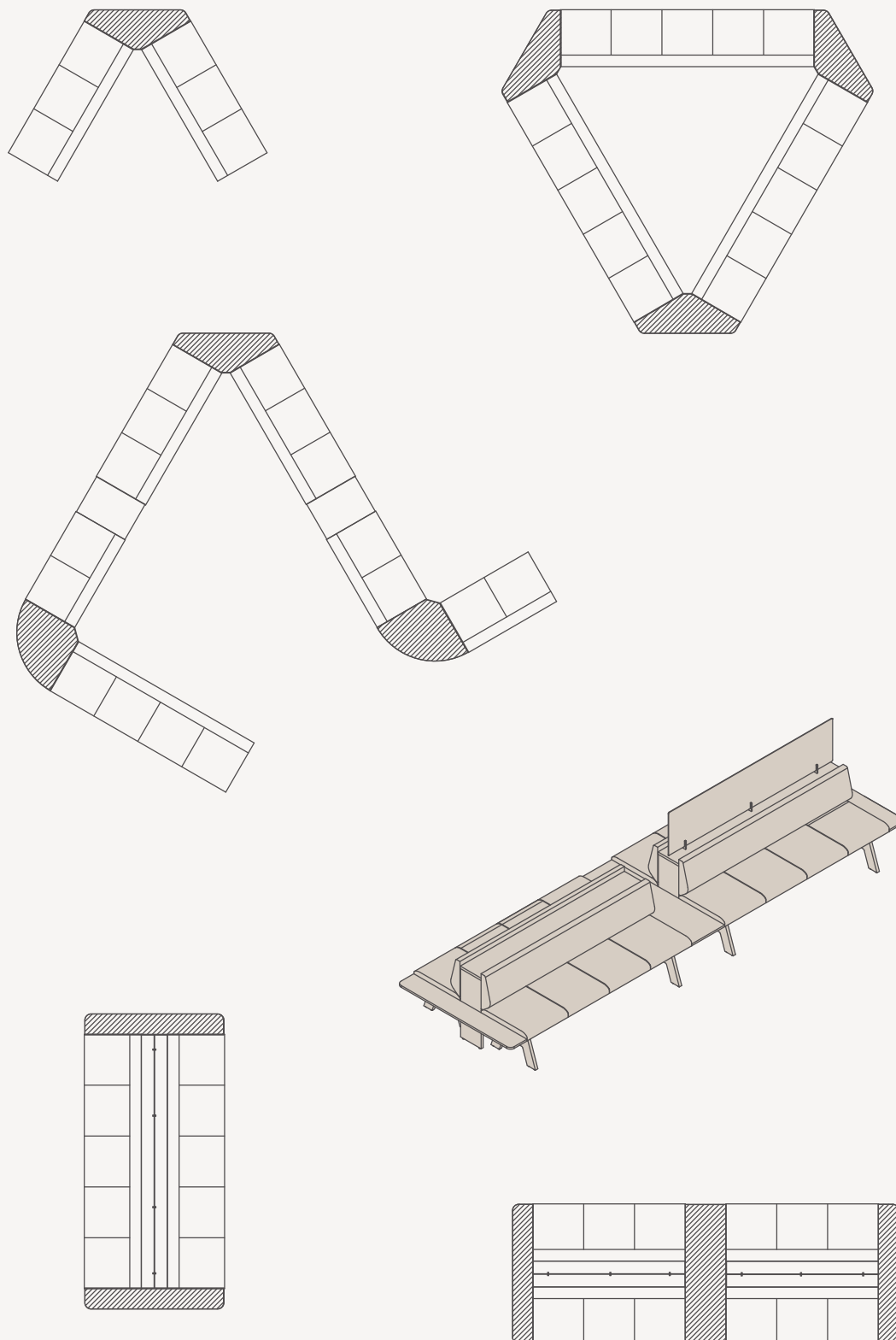

MoDULaRiÉ fonCtionneLLe.
Est complètement modulable, sa conception permet
de réaliser les compositions que chaque espace requiert.



ContraCt & Soft Seating

Banco de espera de 2, 3, 4 ó 5 plazas. Patas de DM de 30mm. lacadas en blanco o negro unidas mediante dos faldones de melamina a juego con las patas. Asiento tapizado sobre tablero contrachapado de abedul de 21mm. de espesor y espuma de 50mm. y 35 Kg/m³ de densidad. Posibilidad de respaldo tapizado sobre tablero contrachapado de abedul de 21mm. de espesor y espuma de 45 Kg/m³ de densidad. Respaldo unido al asiento mediante pletina de acero de 8mm. de espesor acabado en pintura epoxy blanca o negra. Uniones y accesorios fabricados en melamina de 25mm. de espesor.

2, 3, 4 or 5 seater waiting bench. 30mm MDF legs lacquered in white or black joined by two melamine beams to match the legs. Seat upholstered on 21mm thick birch plywood board and 50mm foam and 35 Kg / m³ density. Possibility of upholstered backrest on 21mm thick birch plywood board and 45 Kg / m³ density. Backrest attached to the seat by 8mm thick steel plate finished in white or black epoxy paint. Joints and accessories made of 25mm thick melamine.

Banc d'attente 2, 3, 4 ou 5 places. Pieds en MDF de 30 mm laqués en blanc ou noir réunis par deux poutres en mélamine assorties aux pieds. Assise tapissée sur planche de contreplaqué bouleau épaisseur 21mm et mousse 50mm et densité 35 Kg/m³. Possibilité de dossier capitonné sur panneau de contreplaqué bouleau épaisseur 21mm et mousse 50mm et densité 45 Kg/m³. Dossier fixé à l'assise par plaque d'acier de 8 mm d'épaisseur finition peinture époxy blanche ou noire. Joints et accessoires en mélaminé épaisseur 25 mm.

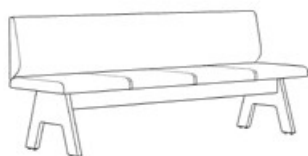

BASEL 1

80
100 / 150 / 200 / 250
56

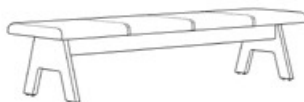

BASEL 2

45
100 / 150 / 200 / 250
56

Altura/ Height / Haut
Anchura/ Width / Large
Fondo/ Depth / Fond

ACABADOS PATAS (FALDONES MELAMINA A JUEGO)

FINISHES LEGS (MATCHING MELAMINE BEAMS) / FINITIONS JAMBES (ASSORTIES AUX PIEDS) / FINITIONS TABLES, ANGLES ET JOINTS

LACA BLANCA LACA NEGRA LACA RAL A ELEGIR



White
Blanc



Black
Noir



Other Lacquer
Laque Ral A Choisir

MESAS, ÁNGULOS Y UNIONES

TABLES, ANGLES AND JOINTS

FINITIONS TABLES, ANGLES ET JOINTS

MELAMINA

Melamine
Melamine

OTROS ACABADOS / OTHER FINISHES / AUTRES FINITIONS

Elementos metálicos: blanco o negro

Metallic elements: white or black

Éléments Métalliques : Blanc Ou Noir

Elementos electrificación: Mirar Tarifa Ismobel

Electrification elements: See Ismobel price list.

Éléments D'électrification : Consultez le tarif Ismobel.

Metacrilatos: Transparente o traslúcido.

Metacrylate rate: Transparent or translucent.

Méthacrylates : Transparent ou translucide.

TAPICERÍA / UPHOLSTERY / TAPISSERIES

Las sillas se pueden tapizar con cualquier tejido o cuero. Las sillas se pueden tapizar con cualquier tejido o cuero de nuestro muestrario (pág. 278) o con tejidos suministrados por el cliente.

Chairs can be upholstered in any fabric or leather. Chairs can be upholstered in any fabric or leather of our sample book (pag. 278) or in COM. Or with the fabrics supplied by the client.

Les chaises peuvent être tapissées avec n'importe quel tissu ou cuir de notre échantillonnage (pag. 278) Ou avec les tissus fournis par le client.



Enrique Larreta, 7 entreplanta -1
28002 Madrid
t. +34 915212260

www.mobiofic.com